

TO-126 Plastic-Encapsulate Transistor

MJE13003 TRANSISTOR (NPN)

FEATURES

- Power Switching Applications

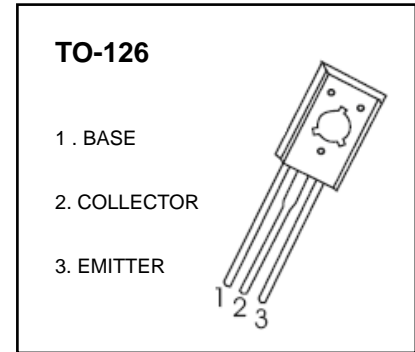

MARKING

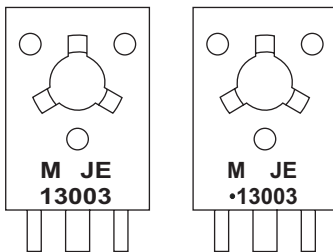

MJE13003=Device code
Solid dot= Green molding compound device, if none, the normal device

Equivalent Circuit

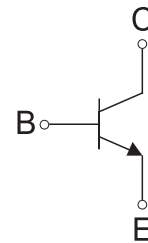

ORDERING INFORMATION

Part Number	Package	Packing Method	Pack Quantity
MJE13003	TO-126	Bulk	200pcs/Bag
MJE13003-TU	TO-126	Tube	60pcs/Tube

MAXIMUM RATINGS (T_a=25°C unless otherwise noted)

Symbol	Parameter	Value	Unit
V _{CBO}	Collector-Base Voltage	600	V
V _{CEO}	Collector-Emitter Voltage	400	V
V _{EBO}	Emitter-Base Voltage	6	V
I _C	Collector Current -Continuous	1	A
P _C	Collector Power Dissipation	1.25	W
R _{θJA}	Thermal Resistance from Junction to Ambient	100	°C/W
T _J , T _{stg}	Operation Junction and Storage Temperature Range	-55~+150	°C

ELECTRICAL CHARACTERISTICS

$T_a=25\text{ }^\circ\text{C}$ unless otherwise specified

Parameter	Symbol	Test conditions	Min	Typ	Max	Unit
Collector-base breakdown voltage	$V_{(BR)CBO}$	$I_C=0.1\text{mA}, I_E=0$	600			V
Collector-emitter breakdown voltage	$V_{(BR)CEO}$	$I_C=1\text{mA}, I_B=0$	400			V
Emitter-base breakdown voltage	$V_{(BR)EBO}$	$I_E=0.1\text{mA}, I_C=0$	6			V
Collector cut-off current	I_{CBO}	$V_{CB}=600\text{V}, I_E=0$			100	μA
Collector cut-off current	I_{CEO}	$V_{CE}=400\text{V}, I_B=0$			100	μA
Emitter cut-off current	I_{EBO}	$V_{EB}=7\text{V}, I_C=0$			10	μA
DC current gain	$h_{FE(1)}^*$	$V_{CE}=10\text{V}, I_C=200\text{mA}$	20		30	
	$h_{FE(2)}$	$V_{CE}=10\text{V}, I_C=250\mu\text{A}$	5			
Collector-emitter saturation voltage	$V_{CE(sat)1}$	$I_C=200\text{mA}, I_B=40\text{mA}$			0.5	V
Base-emitter saturation voltage	$V_{BE(sat)}$	$I_C=200\text{mA}, I_B=40\text{mA}$			1.1	V
Transition frequency	f_T	$V_{CE}=10\text{V}, I_C=100\text{mA}, f=1\text{MHz}$	5			MHz
Fall time	t_f	$I_C=100\text{mA}$			0.5	μs
Storage time	t_s^*	$I_C=100\text{mA}$	2		4	

Typical Characteristics

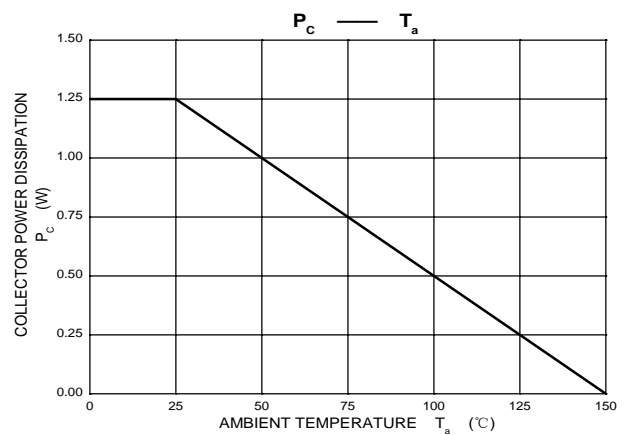
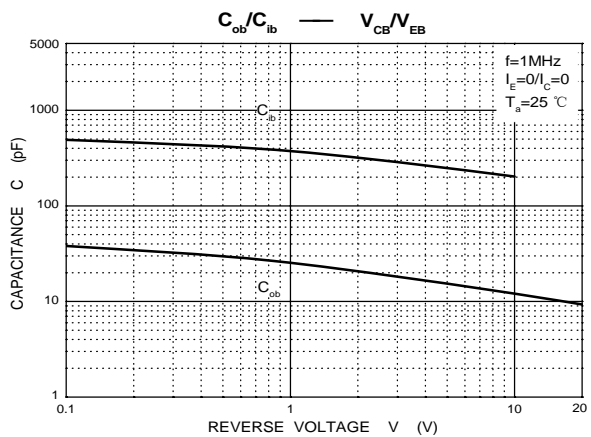
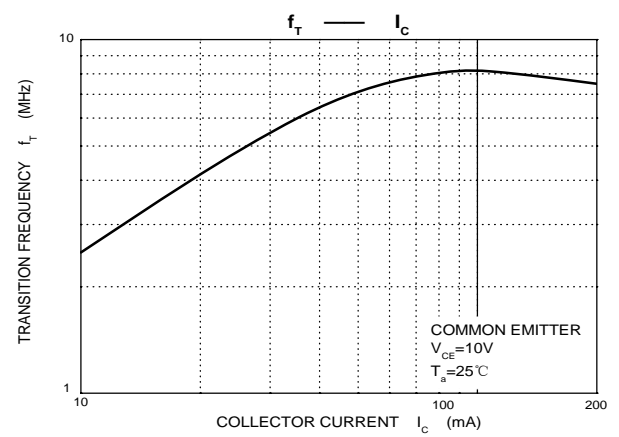
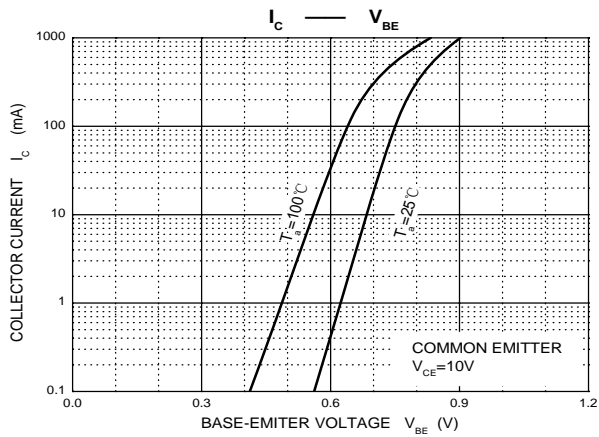
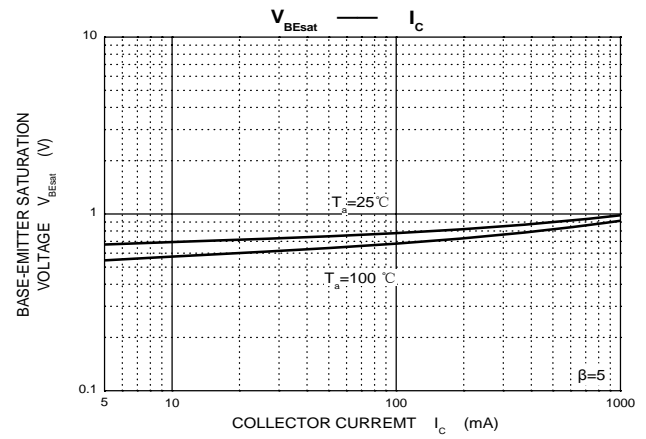
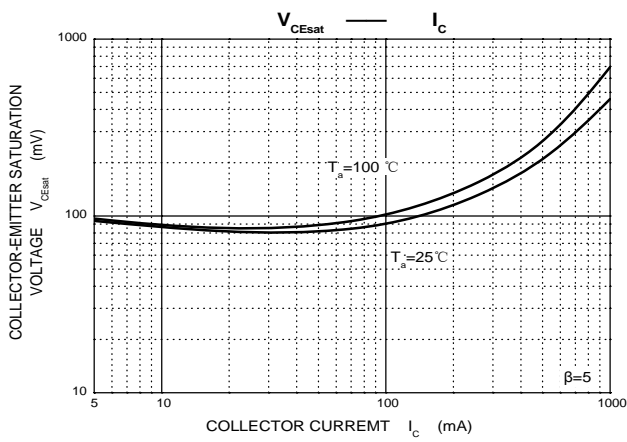
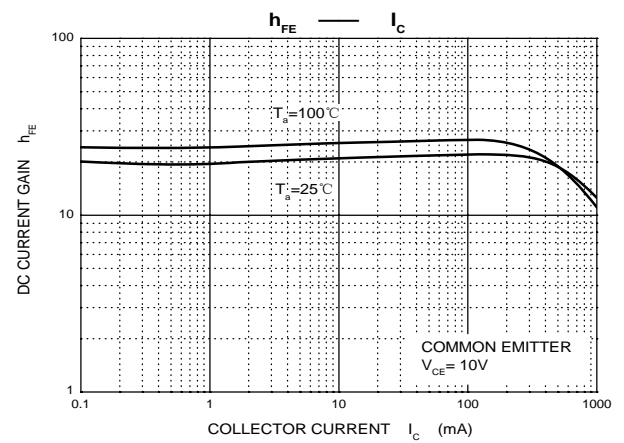
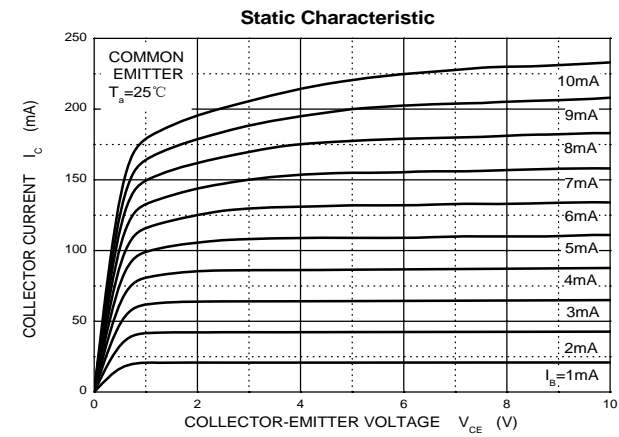

TO-126 Package Outline Dimensions



Symbol	Dimensions In Millimeters		Dimensions In Inches	
	Min	Max	Min	Max
A	2.500	2.900	0.098	0.114
A1	1.100	1.500	0.043	0.059
b	0.660	0.860	0.026	0.034
b1	1.170	1.370	0.046	0.054
c	0.450	0.600	0.018	0.024
D	7.400	7.800	0.291	0.307
E	10.600	11.000	0.417	0.433
e	2.290 TYP		0.090 TYP	
e1	4.480	4.680	0.176	0.184
h	0.000	0.300	0.000	0.012
L	15.300	15.700	0.602	0.618
L1	2.100	2.300	0.083	0.091
P	3.900	4.100	0.154	0.161
Φ	3.000	3.200	0.118	0.126